



ATHENS



Installation Instructions for Athens Fence

It is the responsibility of the installer to meet all code and safety requirements as well as obtain all required building permits. The installer should determine and implement appropriate installation techniques for each installation situation. The Fortress Company and its distributors shall not be held liable for improper or unsafe installations.

Read Instructions Completely Before Starting Installation

Before You Begin

Contact your local Building Code Department for required permits and laws regarding your fence project. If applicable, also contact your Home Owners Association for rules and regulations regarding fence installations in your neighborhood.

Call 811 before you dig post holes to locate and identify any buried utilities.

Required Materials

Tape Measure, Stakes and String, Level, Post Hole Digger, Spade Shovel, Rubber Mallet, Saw, Pliers, Aviation Snips, Speed Square, Pencil, Wheelbarrow, Fortress Paint, Concrete, Eye Protection and other personal protective equipment.

Material Requirements and Fence Layout

To begin your Athens Fence project follow these steps:

- Sketch your project out on a piece of graph paper, include structures and utilities lines that are located on the property.
- Identify the property line and determine the perimeter of your fence project.
- Using a tape measure determine the length of each fence run.
- Athens Fence is easiest to install when starting from a corner. If no Gates are used only one panel should need to be cut.

(2" Post Max On Center Spacing is 71-3/4") (2.5" Post Max On Center Post Spacing is 72-1/4")

- If using 2" Posts divide the length of a fence run by 71-3/4" that will tell you how many post are required for that run.
- If using 2-1/2" Posts divide the length of a fence run by 72-3/4" that will tell you how many post are required for that run.
- Determine the location of gates and mark on drawings. Adjustments to panel length are required at gates.
- Use the sketch to estimate the number of each Post type, Panel and Gates required for you Athens Fence installation.

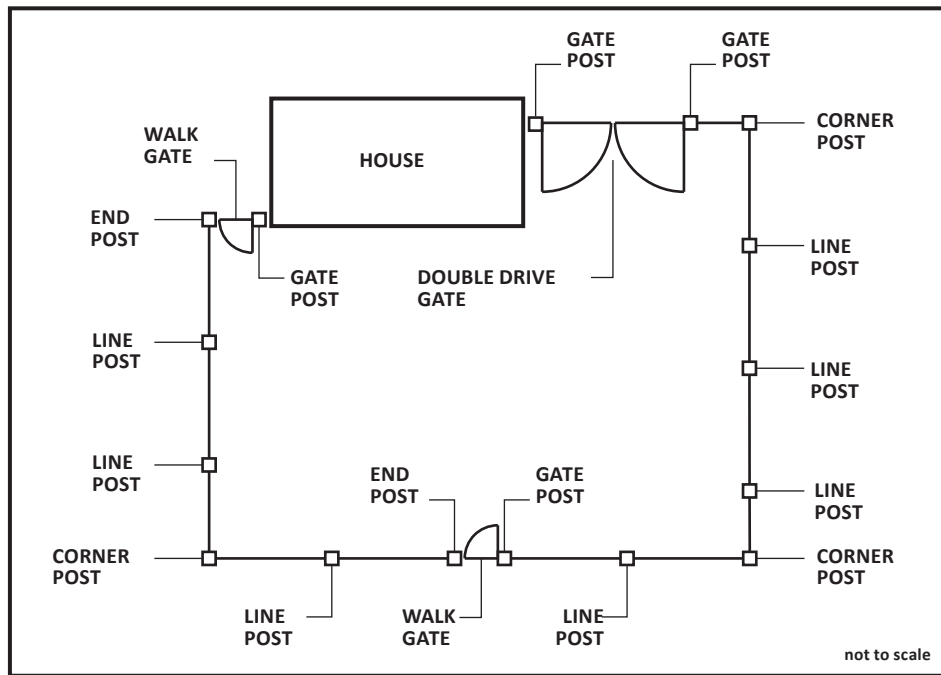

For technical assistance, please email: technicalhelp@fortressfence.com
Hours of Operation: Monday through Friday 8:00 AM to 5:00 PM, CST
Phone: 1-866-323-4766 Fax: 972-644-3720
www.fortressfence.com

Athens Fence Product Options

Posts

- All Athens Fence posts are available as Blank, Line, Corner and End posts.
- Note: .125" posts are recommended to be used for gate posts.**



Blank



Line



Corner



End

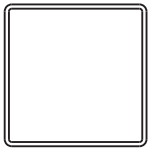

2" x 2" x .060"

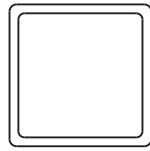

2" x 2" x .125"

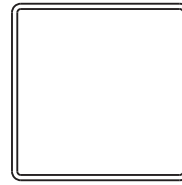

2-1/2" x 2-1/2" x .060"

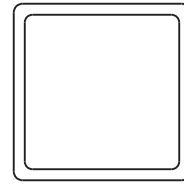

2-1/2" x 2-1/2" x .125"

Panel and Gate Styles

- All Athens Fence Panels have matching Walk and Drive Gates
- Note: 2 and 3 Rail options are available**
- All Athens Fence Panels are rackable to 12-3/8"

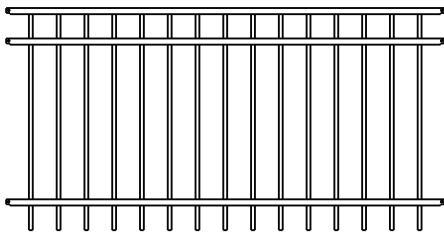

FT3-ATHENS

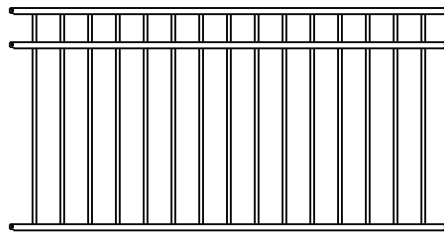

FT/FB3-ATHENS

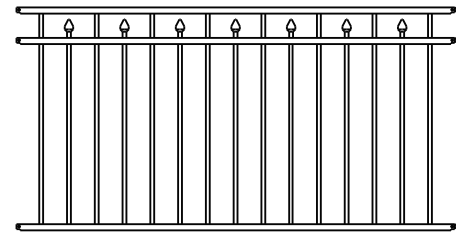

SP/FTFB3-ATHENS

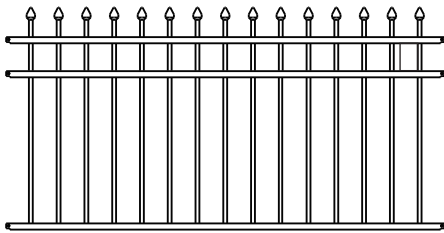

SP/FB3-ATHENS

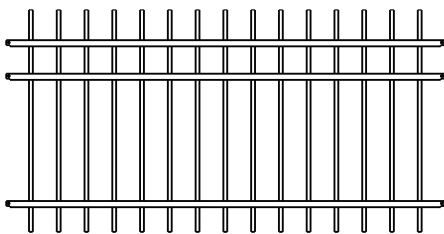

EXT3-ATHENS

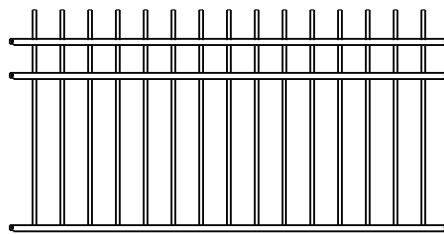

EXT/FB3-ATHENS

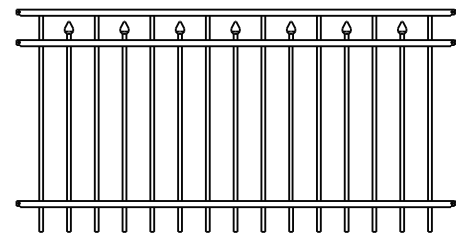

SP/FT3-ATHENS

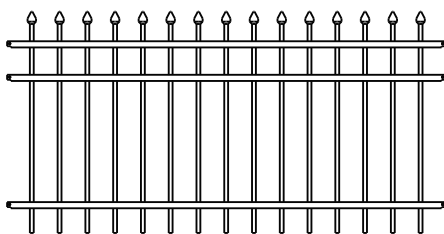

SP3-ATHENS

Fence Layout

Using the fence layout sketch as a guide, locate a corner or reference point along each fence run and mark it with a stake. Use a string stretched between stakes located at the end of each fence run, layout the perimeter of the fence project.

- Layout fence so that minimal panel cuts are required; remember to allow for gates.
- If layout has 90° corners, confirm that corners form 90° angles.
- From starting point, use a tape measure to mark post hole locates.

(2" Post Max On Center Spacing is 71-3/4") (2.5" Post Max On Center Post Spacing is 72-1/4")

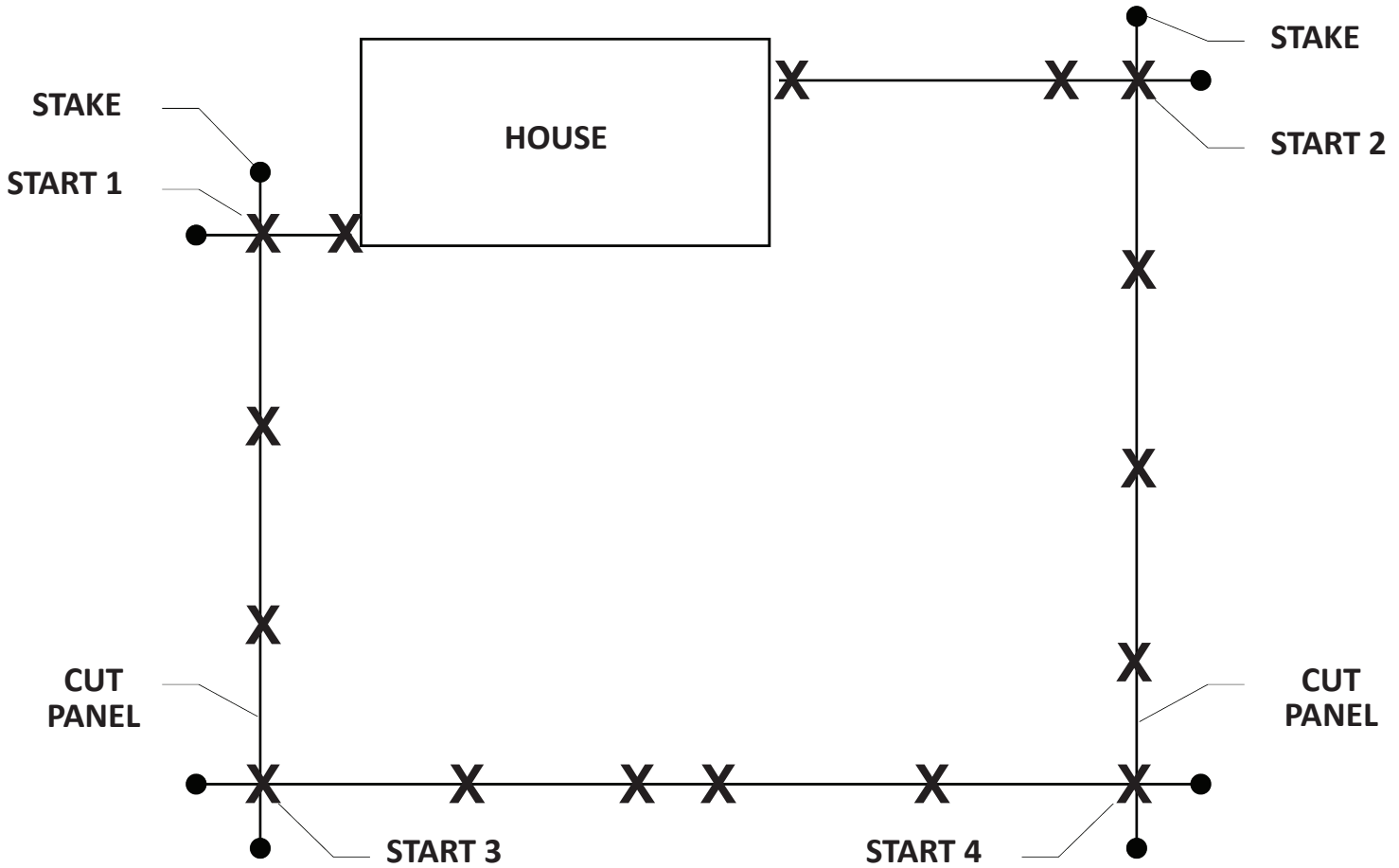

Post Holes

Call 811 before you dig post holes to locate and identify any buried utilities.

Athens Fence Posts must be buried in concrete.

Athens Fence Posts are designed to be buried 21" in a 24" deep post hole, however you should always consult local code requirements for exact depth requirements.

Post holes should be at least 6" in diameter, however you should always consult local code requirements for exact requirements.

Holes must be filled with 3" of pea gravel or crushed stone to allow for drainage. Compact the gravel before setting posts.

Fill holes with concrete to within 1" of the surface of soil.

Use a level to confirm that posts are straight. If required posts can be staked

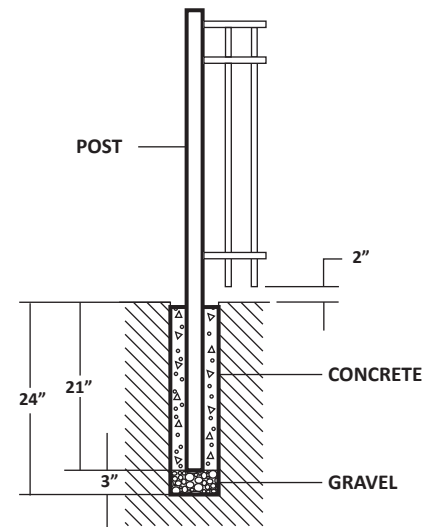

Cutting Panels

- Always design your layout to minimize the number of panels that need to be cut.
 - For best results use a circular saw with a fine tooth carbide tipped blade.
- For best results cut an equal amount from each end of panel.
- Cut one end of panel at a time. Only cut the second end of panel after the Athens Poly-Loc Clip has been reinstalled.
- To Remove Poly-Loc Clip, rotate clip downward and pinch to disengage from rail.

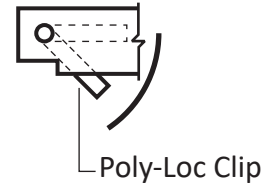
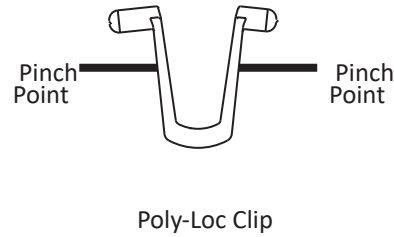
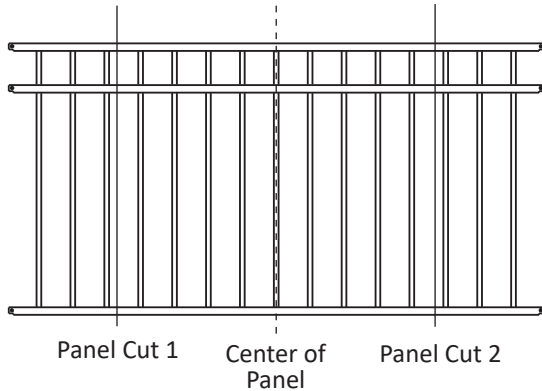

Notching and Trimming Rails

- Cut rail ends must be notched to fit in post. Use aviation snips to make the cuts and file cuts clean.
- A 1/4" diameter hole must be drilled through vertical legs of rail for reinstalling the Poly-Loc Clip.
- See drawing below for notch and hole locations
- Apply two coats of Fortress zinc based touch-up paint to the cut area. Allow paint to dry.
- Reinstall Poly-Loc Clip into rail. Insert the longer pin on Poly-Loc Clip for easier installation.
- Corner posts might require rail ends to be trimmed for clearance. Trim rails as shown.

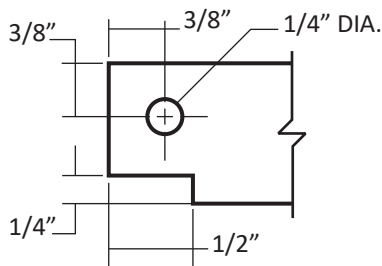

Rail Fabrication

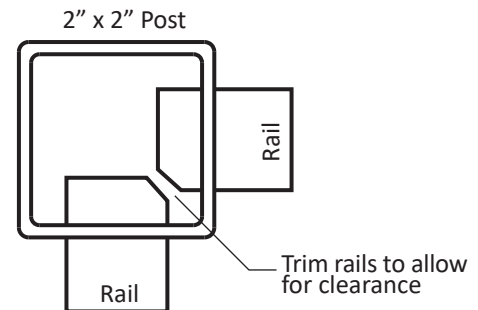

Best Practices

- Install panel into one post at a time. Install Bottom Rail first.
- Install several panels into posts before leveling panels and filling holes with concrete.
- Panels rake in one direction. If you feel resistance when raking the panel you are raking panel in the wrong direction.
- If slope requires panel to be raked, install the high side of panel into post first and rake the panel down before installing in lower post.
- If screws are used to secure rails into post, use a #14 x 1-1/2" self-drilling sheet metal screw.

#14 x 1-1/2" Self-drilling sheet metal screw

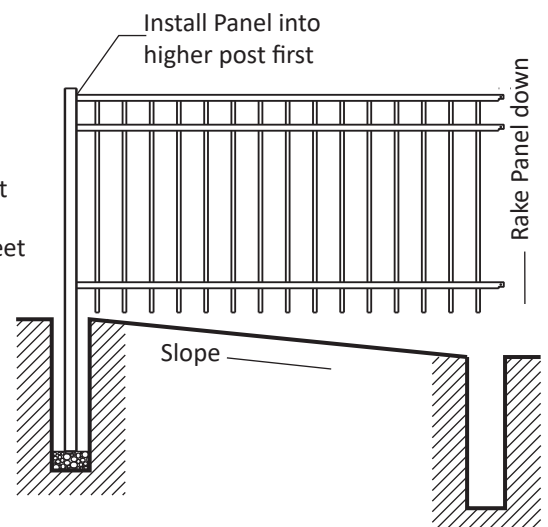
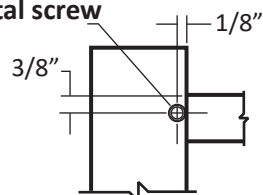

Begin Post and Panel Installation

- Starting at a corner , dig first post hole to required depth.
- Fill hole with 3" of compacted pea gravel or crushed stone.
- Insert Corner Post in post hole and check post depth.
- Insert ends of rails into the post holes.
- Rotate Poly-Loc Clip downward.
- Depress Poly-Loc Clips and insert rail into post
- Rail is installed when Rail Notch contacts post.
- Confirm second post hole location and dig post hole.

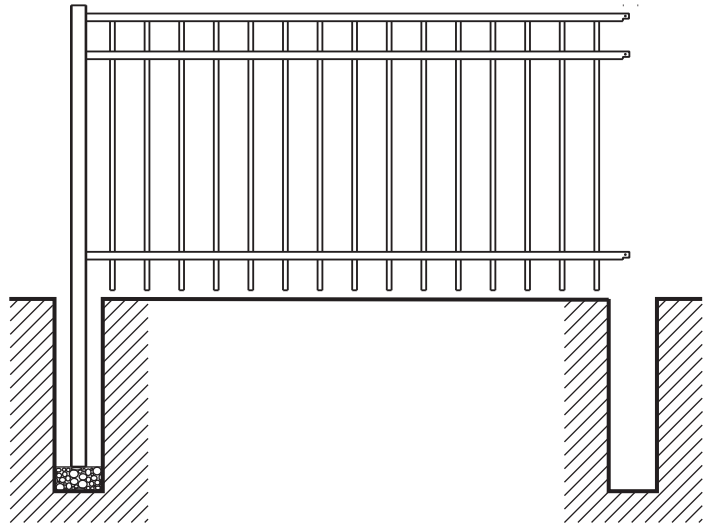
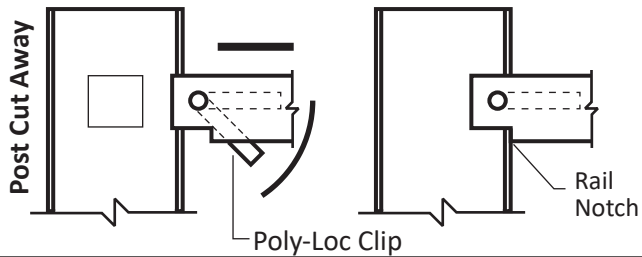

Second Post Installation

- Insert Post into post hole.
- Temporarily insert the rail ends into the post.
- Place a level on top rail of fence panel to check for level.
- Make adjustments to unlevel panel by adding gravel under post
- Once level depress Poly-Loc Clips and insert rail into post.
- **Rail is installed when Rail Notch contacts post.**
- **Do not fill holes with concrete**

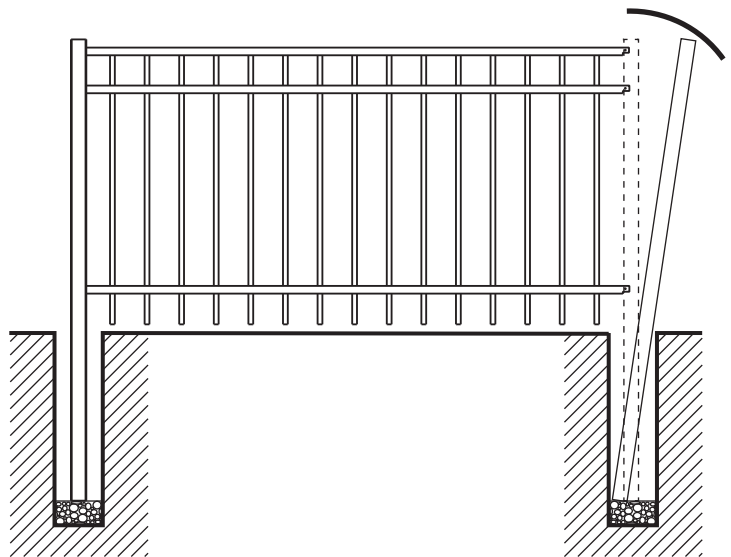

Continue Post and Panel Installation

- Continue process of confirming and digging post holes as panels are installed.
- **Fill posts holes with compacted gravel and check post height.**
- Install and level panels.

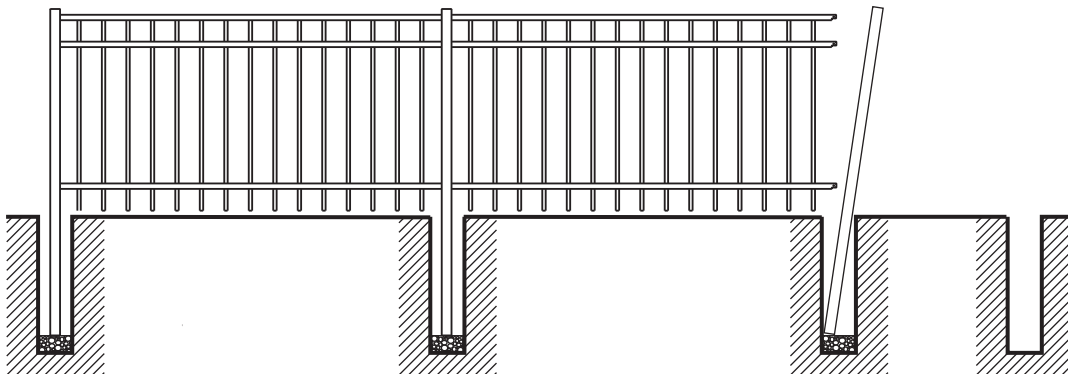

Fill Post Holes with Concrete Continue Post and Panel Installation

- The installation process requires posts and panels to move freely with in the post hole.
- After installing two panels go back to the first post and fill with concrete.
- Use a level to confirm that posts are straight. If required posts can be staked while concrete sets.
- Depending on your fence layout, the last panel in each run might need to cut to length.

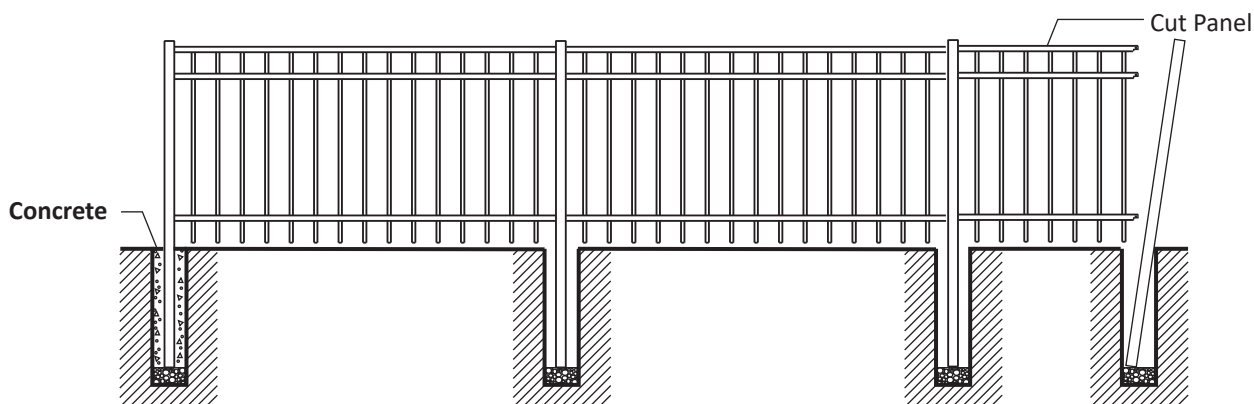

Fill Post Holes with Concrete

- Continue filling post holes with concrete as posts and panels are installed.
- Use a level to confirm that posts are straight. If required posts can be staked while concrete sets.
- Allow concrete to cure for a minimum of 24 hours before using gates.

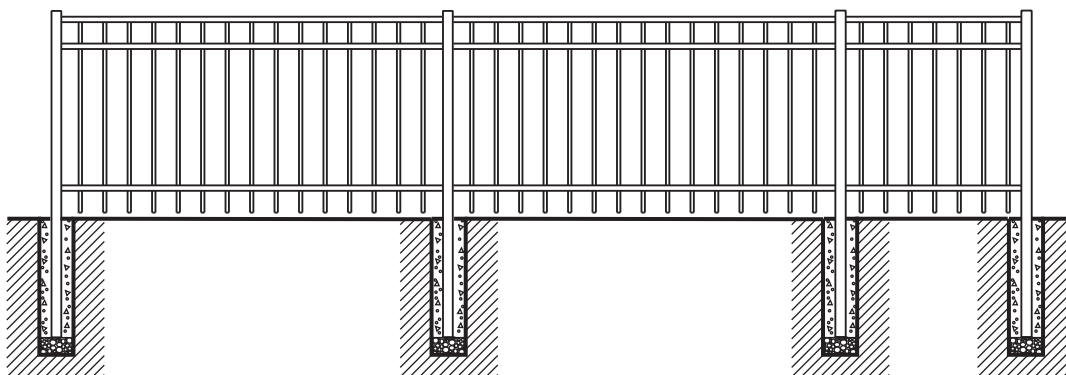



JOIN THE REVOLUTION.

FortressBP.com | 866.323.4766

© 2023 Fortress Building Products.

Unless otherwise noted, all proprietary names are trademarks of Fortress Iron, LP. All rights reserved.

07/2023